



# Owner's Manual Care and Maintenance

---

**INFINITY**<sup>®</sup>  
from **MARVIN**<sup>®</sup>  
REPLACEMENT WINDOWS  
*Built for life*<sup>®</sup>



# Table of Contents

04	<b>INTRODUCTION</b>
04	How to Use this Manual
04	Warranty Registration
05	Hazard Notations
05	<b>ANNUAL CHECKLIST</b>
06	<b>PART IDENTIFICATION</b>
06	Windows
07	Doors
08	<b>GLASS</b>
08	Condensation
08	Mildew Removal
09	Tempered Glass
09	Glass Breakage
09	Cleaning Glass
10	<b>INTERIOR EVERWOOD® FINISH</b>
10	Finishing or Painting EverWood
10	Preparing and Cleaning EverWood
10	Applying a High Quality Gel Stain
11	Applying a Protective Top Coat Finish
11	Applying a Paint Finish
11	<b>BARE INTERIOR WOOD</b>
11	Painting Wood
11	Staining Wood
12	<b>ULTREX® FIBERGLASS</b>
12	Cleaning Ultrex
12	Painting Ultrex
13	<b>HARDWARE</b>
13	Cleaning Hardware
13	Physical Vapor Deposition (PVD) Finish
14	<b>SCREEN</b>
14	Cleaning Screen
15	<b>CARE AND MAINTENANCE</b>
16	Double and Single Hung
19	Slider/Glider
20	Casement
21	Awning
22	Special Shape and Round Top
23	Sliding French/Patio Door
25	Inswing French Door

# Welcome to the Infinity Family

Thank you for your recent purchase of durable, beautiful and low-maintenance Infinity from Marvin windows and doors.

## How to Use this Manual

This manual is designed to teach you the basics about your new Infinity windows and doors. You'll find photos to help you identify your Infinity products, general information on cleaning and answers to common questions. There are also simple, small things you can do to ensure satisfaction. If you have a question or experience a problem with your windows that is not mentioned in this manual, just call your local Infinity partner for help or visit [infinitywindows.com](https://infinitywindows.com).

## Warranty

Infinity from Marvin is committed to bringing you products of the highest quality and value. Our made-to-order manufacturing philosophy is one example of our commitment. Our warranty, another.

Please visit the warranty section of our website [infinitywindows.com/warranty](https://infinitywindows.com/warranty) for full warranty details on your product.

## Warranty Registration

To obtain the Limited Lifetime Warranty, you must register your products with Infinity within 60 days of product installation by completing the Warranty Registration form available at [infinitywindows.com/warranty](https://infinitywindows.com/warranty). You may also register by calling 1-800-533-6898. If you do not register your products within 60 days of installation, you will not receive the Limited Lifetime Warranty; instead, you will receive the 10/20 Limited Warranty.



## Hazard Notations

Please familiarize yourself with the following hazard notations used throughout this manual.



### WARNING

Mistake or misuse could result in personal injury and/or severe damage to unit, equipment and/or structure.



### SEEK ASSISTANCE

Help from another individual is necessary to perform the task safely and correctly.



### CAUTION

Mistake or misuse could cause damage to the window or result in faulty installation and unit performance.



### TIPS/HINTS

Information on alternative procedure, definitions and helpful hints.

## ANNUAL CHECKLIST

# Keep your windows and doors operating smoothly with routine care and maintenance.

- 01 Safety first: use caution on ladders, wear protective eye-wear and clothing. When working with primers, paints, stains, cleaning solutions, etc. make sure to use and dispose according to local codes or manufacturer's instructions.
- 02 Inspect weather strip for damage or loss of performance. Your local Infinity partner can help determine if the weather strip needs replacement. Take care when using paints, stains or varnishes as these products can damage weather stripping.
- 03 Examine window or door's interior and exterior finish. Periodic cleaning and touch-up can extend the life of your finish. (See repainting/refinishing information on pages 10 through 12).
- 04 Inspect exterior caulking around the outer edges of the window or door frame. Trim off any loose caulk and reseal any gaps with a good quality caulk.
- 05 Check all hardware (locks, opening mechanisms, etc.) for smooth operation.
- 06 Inspect exposed hardware screws; tighten if loose.
- 07 Clean sand, dirt or dust from door and window hinges, sills and tracks.
- 08 Life happens, windows and doors get dirty. Wash your windows and door with an approved cleaning solution found at [infinitywindows.com/care](http://infinitywindows.com/care).

# Windows

In this manual, you'll find operation and maintenance information for Infinity from Marvin windows beginning on page 16. Refer to the product illustrations for the names of your particular windows, and use the illustration to help identify window components.

\*Infinity Double Hung shown for illustrative purposes only.

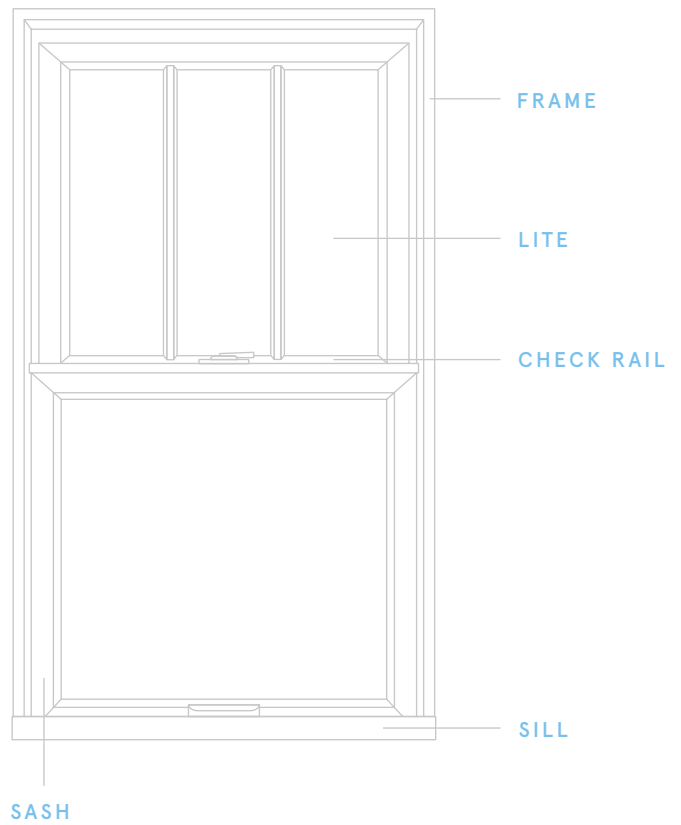

## Infinity Window Styles



DOUBLE AND SINGLE HUNG



SLIDER/GLIDER



CASEMENT



AWNING



SPECIAL SHAPE AND ROUND TOP

# Doors

In this manual, you'll find operation and maintenance information for Infinity from Marvin doors beginning on page 23. Refer to the product illustrations for the names of your particular doors, and use the illustration below to help identify door components.

Sliding French and Sliding patio doors are available in 2, 3 and 4 panel configurations. Inswing French door is available in 1, 2 and 3 panel configurations.

\*Infinity Sliding Patio Door shown for illustrative purposes only.



## Infinity Door Styles



SLIDING FRENCH DOOR

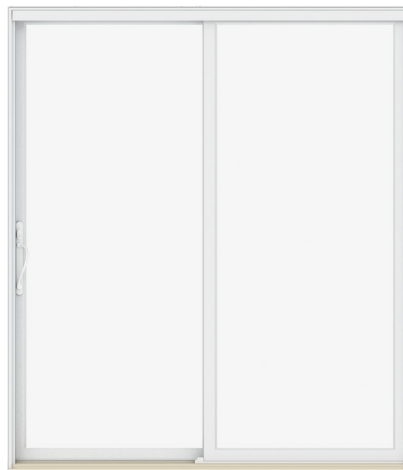

SLIDING PATIO DOOR

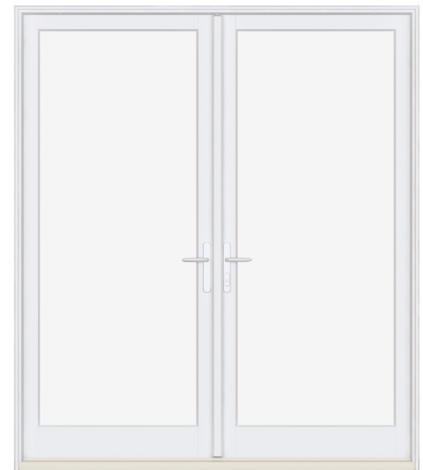

INSWING FRENCH DOOR

# Keep your glass looking and performing it's best.

## Condensation

Before reading this section, pour yourself a nice tall glass of ice water. During cold winters, there is a large temperature difference between inside and outside of your home. When the temperature drops outdoors, the glass on your windows usually has a lower surface temperature than other surfaces in your home and is the first place that you'll notice condensation in your home. This is not due to any defect in your window or door, it's simply a sign of needing to reduce the humidity in your home.

Warm air is capable of holding more moisture than cool air. As warm vapor filled air comes in contact with a cool surface it loses its ability to hold moisture. When moisture laden air reaches its dew point, moisture condenses on the nearest cool surface. Generally the most obvious surfaces in your home where you'll notice condensation are on your windows or the glass of ice water sitting in front of you.

Excessive humidity is more likely to occur in newer or recently remodeled homes with tight, energy efficient construction, causing a build-up of moisture to the interior. Information on excessive humidity and how to reduce condensation on your windows can be found on the Internet by searching for "window condensation".

## Mildew Removal

If your home has excessive interior moisture, you may experience some discoloration on various parts of your home, including the lower portions of your windows or doors. This discoloration may be the result of mildew growth and can be removed with an approved cleaning solution found at [infinitywindows.com/care](http://infinitywindows.com/care).

Mildew is a fungus that thrives on warmth and moisture. Mildew growth is usually brown or black in color and may be mistaken for dirt. The presence of mildew can be confirmed by placing a drop of household bleach on the suspected mildew area. If small gas bubbles develop in the droplet of bleach, mildew does exist and can be removed with an approved cleaning solution found at [infinitywindows.com/care](http://infinitywindows.com/care).



Wear protective eyewear and skin protection, and keep the area well ventilated.  
Make sure the surface is clean and reapply if the discoloration persists.





## Tempered Glass

Tempered glass is sometimes used on Infinity windows and doors for code or safety reasons. Tempered glass is heated and cooled at an accelerated rate, adding strength and shatter resistance. You may notice a slight amount of distortion – this is normal and due to the tempered glass manufacturing process. The logo in the corner of each piece of tempered glass is required by code and safety regulations.

## Glass Breakage



Should the glass in your window or door break, make sure you use the appropriate personal protection equipment to remove the broken glass; eyeglasses or goggles, sturdy gloves and heavy protective clothing. Dispose of broken glass in a secure container. Failure to properly handle and dispose of glass could result in injury.

\*Contact your Infinity partner for information on sash or panel replacement.

## Cleaning Glass

The best method to clean the glass on your Infinity products is to first soak the glass surface with clean water to loosen dirt or debris. Use an approved cleaning solution found at [infinitywindows.com/care](https://infinitywindows.com/care) and apply with a scratch resistant applicator. Immediately after washing the glass, remove all of the cleaning solution with a squeegee. Make sure no harsh particles are trapped between the glass and the cleaning material. Window and door gaskets, sealants and frames are susceptible to deterioration if cleaning solutions are not rinsed and dried after cleaning.



Do not use razor blades, knives or scrapers for cleaning glass surfaces.

## DO

- Clean glass when dirt and residue appear
- Determine if coated glass surfaces are exposed
- Exercise special care when cleaning coated glass surfaces
- Start cleaning at the top of the building and continue to lower levels
- Soak the glass with clean water to loosen dirt and debris
- Use an approved cleaning solution found at [infinitywindows.com/care](https://infinitywindows.com/care)
- Dry all cleaning solution from window gaskets, sealants and frames
- Clean one small window and check to see if procedures have caused any damage

## DON'T

- Use scrapers of any size or type for cleaning glass
- Allow dirt and residue to remain on glass for an extended period of time
- Clean tinted or coated glass in direct sunlight
- Allow water or cleaning residue to remain on glass or adjacent materials
- Begin cleaning without rinsing excessive dirt debris
- Use abrasive cleaning solutions or materials
- Allow metal parts of cleaning equipment to contact the glass
- Trap abrasive particles between the cleaning materials and glass surface

# Looks and stains like wood — without the maintenance.

Read these instructions thoroughly before beginning to stain or paint your Infinity window or door. Once finished, it is very difficult to remove the stain or paint and refinish the unit.

## Finishing or Painting EverWood

Stainable, paintable Infinity products feature EverWood, an interior engineered wood grain surface that requires a paint or gel stain finish to be applied before or immediately after installation.



When applying gel stain or paint finish avoid contact with plastic or vinyl parts such as weather strip, hardware, handles or rollers. Stain and paints can cause damage and may require replacement.

### DON'T

- Sand or use abrasive cleaners on EverWood.
- Allow EverWood to come in contact with petroleum distillates such as benzene, toluene or kerosene.
- Allow EverWood to come in contact with silicon or other adhesives prior to finishing.

## Preparing and Cleaning EverWood

Clean the EverWood surface with a damp cloth soaked in warm water. Wipe down with a dry cloth and allow the surface to thoroughly dry. If the surface has become soiled try cleaning with an approved cleaning solution found at [infinitywindows.com/care](http://infinitywindows.com/care). Rinse off cleaning residue with warm water and let thoroughly dry.

## Applying a High Quality Gel Stain

Read and follow gel stain manufacturer's instructions and warnings for application, preparation and clean-up. Apply the gel stain with a brush in the direction of the wood grain on the supplied test strip of EverWood to determine if the gel stain adequately matches your existing finish before applying stain to the unit.

If the stock gel stain applied to the EverWood test strip does not match your existing finish it is possible to custom mix gel stains by adding colorants or combining colors. The exact process will depend on the brand of gel stain you are using. Infinity recommends contacting a stain/paint specialty store to custom mix a matching color for your application.

After a good match has been obtained on a sample apply gel stain evenly with a brush to the unit.



## Applying a Protective Top Coat Finish

Let the gel stain dry overnight. Test an area to see if the surface is dry by wiping the stained surface with a clean cloth. If stain appears on the cloth the stain needs to dry longer. After the stain has completely dried, Infinity recommends using a high quality water-based polyurethane finish. Follow the finish manufacturer's instructions and warnings for application, surface preparation and clean up. Use a clean brush to apply a top coat, lightly sand the surface with 400 grit sandpaper taking extra care not to sand through the finish surface, then apply one more coat of finish.

## Applying a Paint Finish

Read and follow the paint manufacturer's instructions and warnings for application, preparation and clean up. Test a high-quality latex or oil based paint applied in the direction of the wood grain on a sample piece of EverWood before applying paint to the unit.



EverWood does not require the use of a prime coat.  
One coat of high quality paint generally provides adequate coverage.

---

### BARE INTERIOR WOOD

# Finishing or painting bare wood products from the Marvin Elevate Collection.

If you have a brand new, bare wood Elevate door, you must finish it immediately to prevent possible damage to the wood. Make sure bare wood door interior surface is clean and dry. Remove any handling marks, debris or effects of exposure to moisture by sanding lightly with fine sandpaper and wiping clean before applying your choice of finish. It is important that you do not paint locks, hardware, weather strip or jamb liners. Avoid contact with plastic parts and vinyl weather strip; paint and stain can damage these parts.

## Painting Wood

Use only a high quality oil base or latex paint. To provide a good adhesion of paint, a compatible prime coat should be applied. Paint with panels opened or removed, do not close until thoroughly dry. Apply one coat of primer and two coats of top quality paint according to the paint manufacturer's instructions.



Do not apply paint to the Marvin Elevate Collection factory prefinish without first contacting your Infinity dealer for proper instructions.

## Staining Wood

Apply stain according to the manufacturer's instructions. Apply as many coats of stain as necessary to achieve the desired color. After the stain is thoroughly dry, apply at least two coats of finish. Marvin recommends varnish or polyurethane.



Prior to staining natural wood it is desirable to apply a wood conditioner to obtain a more even finish. Follow manufacturer's instructions.

# Easy cleaning for a fiberglass finish that lasts.

Infinity windows and doors are built with strong, durable Ultrex fiberglass that is 8 times stronger than vinyl. Our proprietary finish is three times thicker than the competition, and performs without fear of UV degradation – and is virtually maintenance free. No sanding, scraping or painting required.

## Cleaning Ultrex

Remove dirt by washing with an approved cleaning solution found at [infinitywindows.com/care](https://infinitywindows.com/care) and rise with water. Clean with a soft cloth or soft brush to remove any bugs, grime, dirt or dust. Do not use an abrasive applicator or use extreme pressure.

No solvents, paint thinner or other chemicals of any type are recommended for use with Ultrex, as they may affect the functionality and appearance of the coating.

### DON'T

- Apply approved cleaning solutions with any abrasive materials or applicators.
- Use a scrubbing action or extreme pressure.
- Use solvents, paint thinner or other chemicals, as they may affect the integrity, functionality and appearance of the coating.



Do not allow Naptha to come in contact with EverWood® material.

## Painting Ultrex

You will need to supply:

- 320-400 grit sandpaper
- Masking tape
- Foam painting brush
- Quality exterior grade acrylic latex paint

01 Thoroughly sand the factory finish with 320-400 grit sandpaper.

02 Wash the surface with water and an approved cleaning solution found at [infinitywindows.com/care](https://infinitywindows.com/care) to remove contaminants, rinse with clear water and dry thoroughly.

03 Mask any window components that will not be painted.

04 Coat the Ultrex with a quality exterior grade acrylic latex paint.

05 Acrylic latex products gain full adhesion after seven to ten days cure.

# Keep handles and locks looking their best.

## Cleaning Hardware

Use a clean, soft, damp cloth to polish and remove fingerprints from window and door hardware. To remove heavier deposits, use an approved cleaning solution found at [infinitywindows.com/care](https://infinitywindows.com/care). Remove traces of water and cleaner and dry thoroughly with a soft cloth. When using any proprietary cleaner always follow the advice given by the manufacturer.

## DON'T

- Use household cleaners, window cleaning solutions, abrasive cleaners, bleaches, solvents, polishes or other chemicals unless specifically recommended by the hardware's manufacturer.
- Allow keys, rings or other sharp objects to strike the hardware.

## Physical Vapor Deposition (PVD) Finish

PVD finishes are available as an option for door hardware. PVD hardware undergoes a state of the art process known as Physical Vapor Deposition. A layer of hard-wearing metals are deposited onto the solid brass substrate which means it has been given a tough finish to resist fading and discoloration by direct sunlight, humidity and most other environmental factors, even in coastal areas.

To help retain the appearance of your PVD products for many years to come, a little periodic maintenance is required to remove any atmospheric deposits from the surface of the product.

- Once every two months clean the surface of the product thoroughly with a non-abrasive cloth and warm water.
- To remove heavier deposits, use an approved cleaning solution found at [infinitywindows.com/care](https://infinitywindows.com/care). Remove traces of water and cleaner and dry thoroughly with a soft cloth.
- When using any proprietary cleaner always follow the advice given by the manufacturer in handling cleaning materials.
- Do not use any abrasive cleaning materials or solvents when cleaning your PVD products.

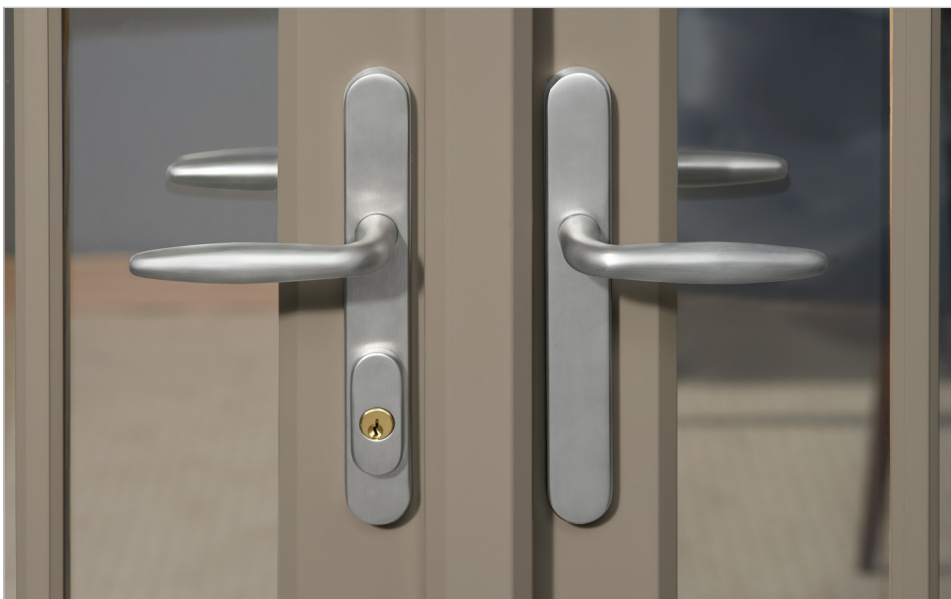

# Keeping your screens clean.

## Cleaning Screen

Remove the screens, lay them on a flat clean area and spray off any dust or debris with water from your garden hose. Allow the screens to completely air dry before replacing in the window or door. If you live in a cold climate, it is recommended that in the winter you remove the screen from your doors. The mesh may collect snow and ice, causing it to sag. Please see individual sections for instructions on screen removal. Contact your Infinity partner if you require assistance with screen replacement.



Infinity screens are designed to stand up to everyday use. However, screens are not intended to act as a safety device. Do not allow children or pets to sit or play on window sills, or to push or fall against window screens, as this could result in a fall through the window or door opening.



Screen will not stop child from falling out window.  
Keep child away from open window.



# Taking care of your Infinity windows and doors.

In the following pages you'll find maintenance information on individual Infinity products. Refer to the product illustrations for the names of your particular windows or doors.

Information in this section includes maintenance and operational tips. Read completely through the instructions before beginning to work on your windows to make sure you have any necessary tools and parts.

Exterior finishes on doors can be cared for in the same manner as Infinity windows. See interior and exterior maintenance information. Take care with your door's sill – make sure you prevent damage by not getting any paint, solvent or chemicals on sills. See individual door sections for any specialized sill care.

If you are having problems not explained in this manual, or continue to have issues, contact your local Infinity partner.



When contacting your Infinity partner it may be helpful to provide them with the "Customer Service Serial Number" etched on the upper right corner of the glass.



LOW E3 OPTION



LOW E2 OPTION

# Double and Single Hung

## Operation and Maintenance

Double hung windows have two operable sash in the frame that slide up and down. Single hung windows have a fixed upper sash and a bottom sash in the frame that slides up and down.

Periodically clean the jamb where the sash slides. Keep dirt and grease free by washing with a gentle dish detergent. Check the exterior caulking on your double hung windows annually. Visit [infinitywindows.com/windows/double-hung](https://www.infinitywindows.com/windows/double-hung) or [infinitywindows.com/windows/single-hung](https://www.infinitywindows.com/windows/single-hung) to find videos on proper cleaning and operation.

## How to Tilt Your Double and Single Hung

To tilt the bottom sash, unlock the unit and raise the sash about 4". Push down on the tilt button located on top of the sash lock base. Rotate the sash lock past the tilt button and ease top edge of bottom sash to a horizontal position.

To tilt the top sash, lower the sash about half-way. Pull the tilt latches inward (located on the top edge of the sash rail) simultaneously until they clear unit frame. Ease top of sash to a horizontal position.

\*Only the bottom sash will tilt on a single hung window.





## Removing Double and Single Hung Sash

To remove the bottom sash, tilt the sash using the same technique described in the previous section. When sash is in a horizontal position, lift both sides of the sash upward 2-3" (51-76 mm) (raising pivot pins out of each clutch). Now rotate the sash until pivot pins clear the jambs and remove the bottom sash from the frame.

To remove the top sash, tilt the sash using the same technique described in the previous section. When the sash is in a horizontal position, lift both sides upward 2-3" (51-76 mm) (raising pivot pins out of each clutch). Finally, rotate the sash until the pivot pins clear the jambs and remove the top sash from the frame.



Larger sized sash can be heavy and awkward to handle. To avoid injury use assistant to remove larger sash.

## Replacing Double and Single Hung Sash

Hold the sash exterior side up with the top rail facing towards you. Rotate and insert the sash so the sash pins clear the frame and place it so the lower sash pin is 2-3" (51-76 mm) above the clutch. Rotate the sash to the horizontal position and lower it down until the pivot pins are fully seated into the clutches. Simultaneously pull in on both tilt latches and tilt the sash up into place. Release the tilt latches and operate the sash to ensure that the sash is operating smoothly. Check sash pivot pins to ensure they are fully engaged in the clutch cams before proceeding.

Repeat above procedures for bottom sash, except retract the sash check rail guides with the tilt button on the sash lock base when installing.

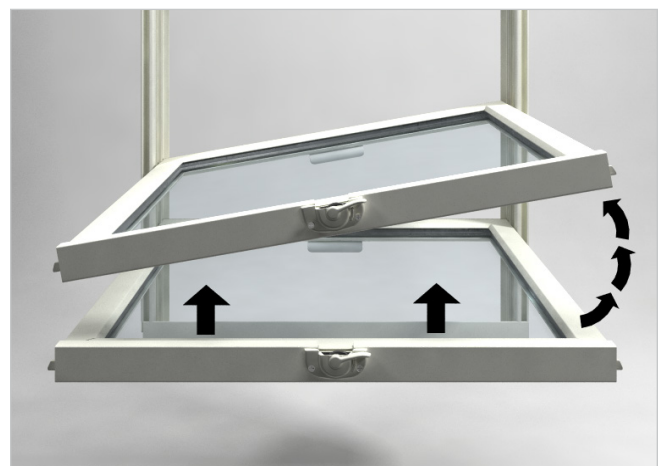

## Resetting a Slipped Clutch Assembly

Measure the clutch dimension from sill on the opposing balance assembly for the same sash and temporarily mark that dimension on the jamb carrier that contains the released clutch, must be within 1/8" (3 mm). Using a flat screwdriver, rotate the balance clutch cam in the clutch assembly to the released position. Hold the screwdriver firmly and slide the clutch assembly down the jamb carrier to the mark. Rotate the balance clutch cam to the open locked position (cam opening up). Release the screwdriver carefully from the clutch assembly (it must lock in place or damage will occur). Compare clutch heights from the sill for the sash affected. They MUST be within 1/8" (3 mm) of each other or damage may occur when sash are reinstalled, adjust height as needed.



Clutches are under extreme spring tension.

## Removing and Installing the Screen

To remove the screen lift up the bottom sash to its fully raised position. Grasp and pull inward on both plunger bolts and push outward on the screen. Grasp the frame of the screen and pull down slightly on the screen until it clears the screen channel. Turn the screen sideways and bring it in through the bottom sash opening. To replace the screen reverse the above procedure.

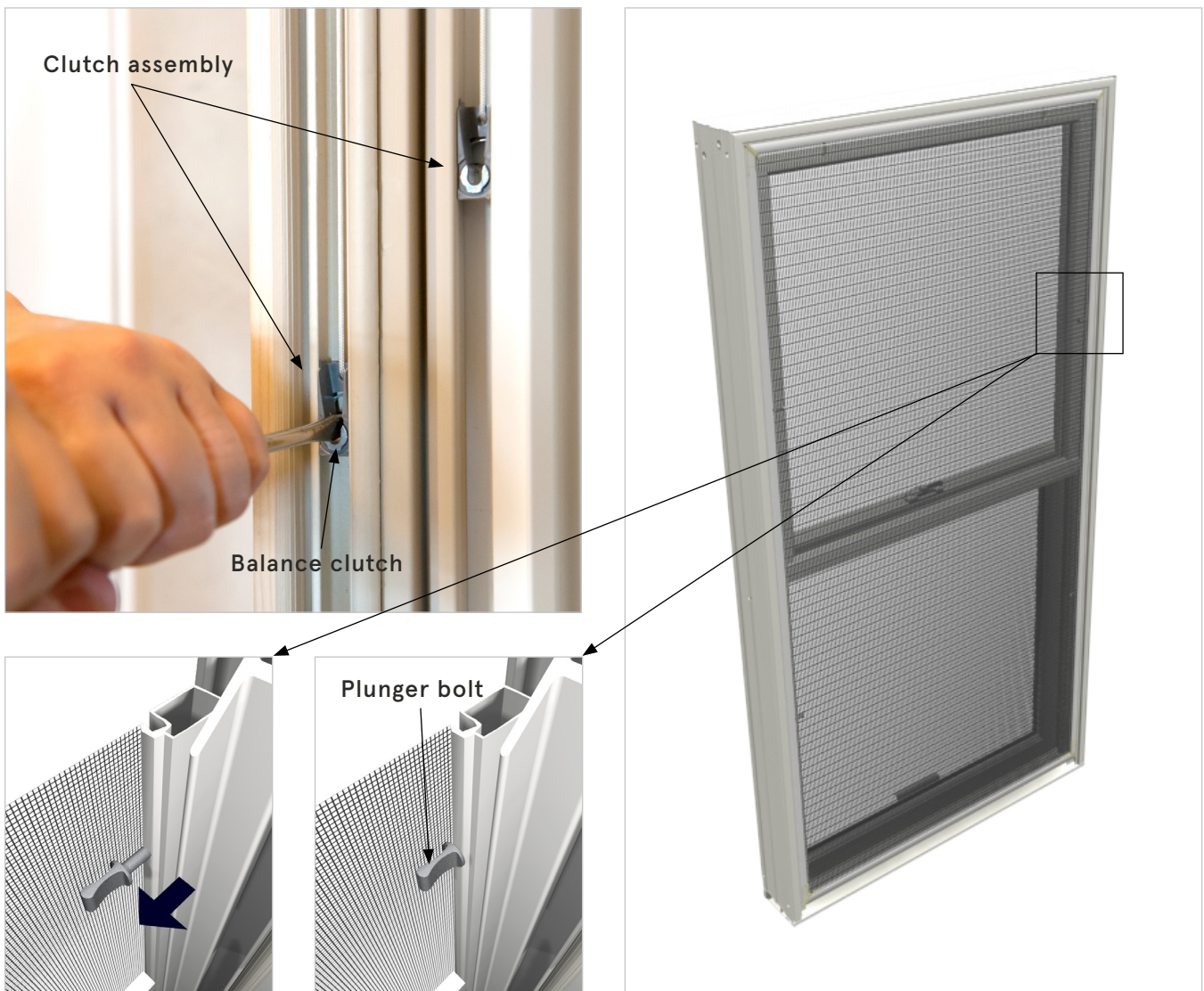

# Slider/Glider

## Operation and Maintenance

Slider windows glide horizontally from the left or right.

Periodically clean the tracks where the sash must glide. Keep tracks dirt and grease free, clean surface with a damp cloth soaked in warm water and wipe down with a dry cloth allowing the surface to thoroughly dry. Visit [infinitywindows.com/windows/slider](http://infinitywindows.com/windows/slider) to find a video on proper cleaning and operation.

## Removing Slider Sash

Slide the operating sash to stationary side of the unit (2"-3" (51-76 mm) from stationary jamb). With latches depressed, located at the top of the sash, tilt the sash inward until it clears the unit frame; lift the sash off the sill track. To replace the sash, reverse the above procedures.

\*Only the operating sash of a slider can be removed from the frame.

## Removing and Installing the Screen

To remove the screen open the operator sash completely. Grasp the screen pull tabs located on the jamb stile side of the screen. Pull the tabs toward the center of the unit until the screen frame can clear the screen channel. Push the screen out to the exterior and turn diagonally to bring into the dwelling.

Replace the screen with the operator sash completely open and position the screen on the exterior of the window with the springs toward the meeting stile of the unit. Making sure the springs are seated in the screen channel, pull on side tabs until the screen clears the frame. Pull screen in toward the interior until the jamb stile of the screen aligns with screen channel; release tabs.

\*Pull tab away from frame and then push out.

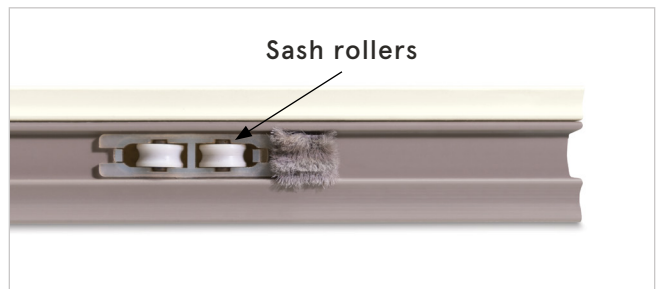

# Casement

## Operation and Maintenance

Casement windows are side-hinged to swing out from the left or right and crank in and out. The roto-gear is the operating mechanism that opens and closes your casement windows. Your casement lock seals the window tightly closed, so excessive cranking when closing your window does not improve the seal and may damage your roto-gear.

Roto-gears should be lubricated once a year with white lithium grease (available at any hardware store) to keep operation smooth. The hinge joints and locking mechanism should be lubricated on occasion with a silicone based spray. Be sure to clean off all dirt, debris or sand before lubrication.



Excessive lubrication may cause damage to the finish of your window.  
Avoid getting oil and solvents on your finish.  
Make sure that any excess is immediately removed.

The sash tracks should be occasionally cleaned out with a soft bristle brush. Visit [infinitywindows.com/windows/casement](http://infinitywindows.com/windows/casement) to find a video on proper cleaning and operation. If your casement is less than 24 3/8" (721 mm) in width, your roto-gear arms and assembly may differ from those shown below.

## Removing and Installing the Screen

To remove casement screen, grasp screen clip. Lift upward and draw screen towards you, removing screen from channel.

To install casement screen, place screen into the upper screen channel. Lift upward and push screen tight against frame. Release screen lift to seat screen into place.

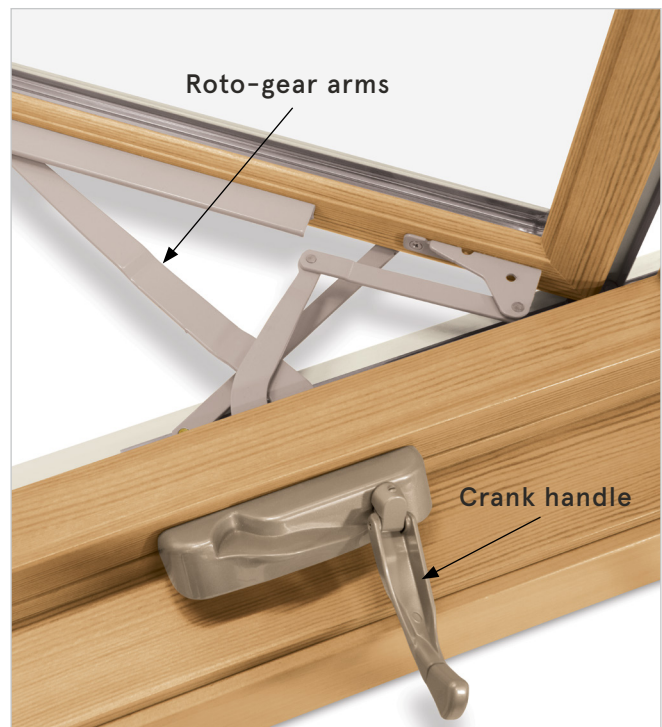

# Awning

## Operation and Maintenance

Awning windows are top-hinged and swing out from the bottom. The roto-gear is the operating mechanism that opens and closes your awning windows. Your awning lock seals the window tightly closed, so excessive cranking when closing your window does not improve the seal and may damage your roto-gear.

Roto-gears should be lubricated once a year with white lithium grease (available at any hardware store) to keep operation smooth. The hinge joints and locking mechanism should be lubricated on occasion with a silicone based spray. Be sure to clean off all dirt, debris or sand before lubrication.



Excessive lubrication may cause damage to the finish of your window.  
Avoid getting oil and solvents on your finish.  
Make sure that any excess is immediately removed.

The sash tracks should be occasionally cleaned out with a soft bristle brush. Visit [infinitywindows.com/windows/awning](https://infinitywindows.com/windows/awning) to find a video on proper cleaning and operation.

## Removing and Installing the Screen

To remove awning screen, grasp screen clip. Lift upward and draw screen towards you, removing screen from channel.

To install awning screen, place screen into the upper screen channel. Lift upward and push screen tight against frame. Release screen lift to seat screen into place.

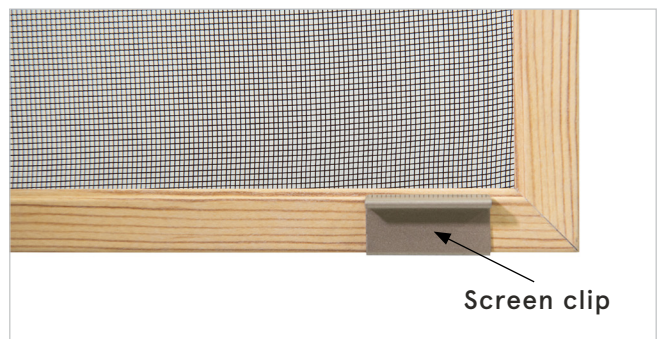
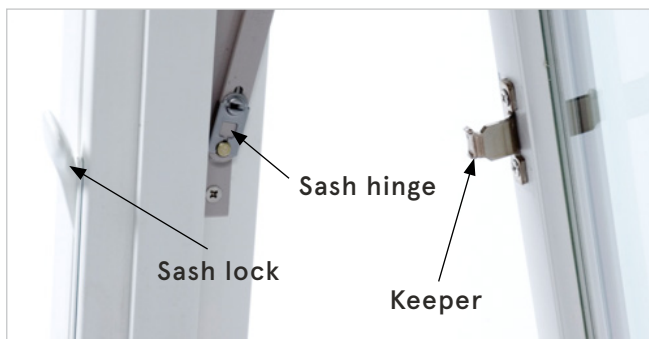
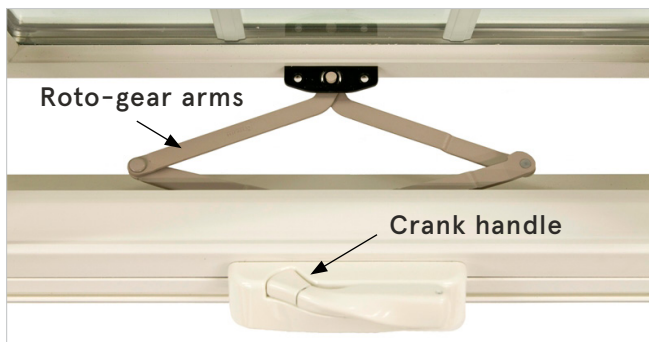

# Special Shape and Round Top

## Maintenance

Most Infinity Round Top and Special Shape windows and all Direct Glaze windows are non-operational, meaning they do not open or close, so there are no maintenance requirements for hardware or weather stripping. Clean the glass occasionally, and maintain the interior or exterior surfaces on the same schedule as your other windows. Visit [infinitywindows.com/windows/special-shape](https://infinitywindows.com/windows/special-shape) or [infinitywindows.com/windows/round-top](https://infinitywindows.com/windows/round-top) to find videos on proper cleaning.

### Special Shapes

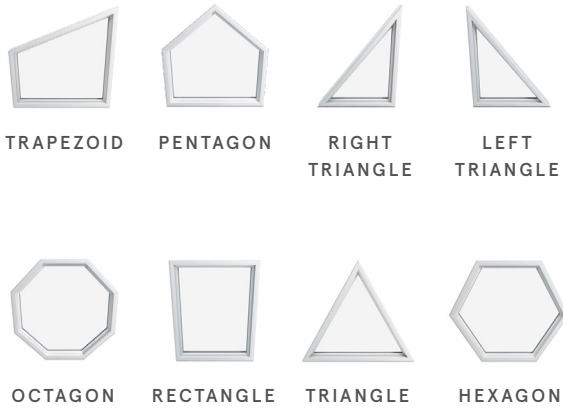

### Round Tops

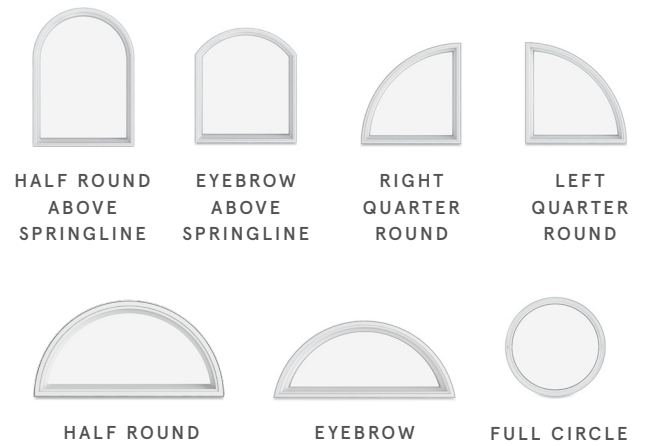

# Sliding French/Patio Door

## Operation and Maintenance

The Sliding French/Patio doors slide horizontally and require very little maintenance to keep them functioning efficiently.

Most problems can be eliminated by keeping the sill clean – ensuring smooth door operation. Door handles can be wiped down with a damp cloth to remove fingerprints and smudges. It is very seldom that door rollers, lock and hinges require lubrication. Occasionally use spray lubricant to keep operation smooth (rollers are visible underneath the operator panel). Visit [infinitywindows.com/doors/sliding-french](https://www.infinitywindows.com/doors/sliding-french) or [infinitywindows.com/doors/sliding-patio](https://www.infinitywindows.com/doors/sliding-patio) to find videos on proper cleaning and operation.

If you live in a cold climate, it is recommended that you remove the screen door in the winter. The screen mesh may collect snow and ice, causing it to sag. If you need door panels removed, please contact your Infinity partner for either detailed instructions or for a service person to remove the panel for you.

## Panel Adjustment Procedure

If necessary, panel adjustment allows you to make minor adjustments to your Infinity Sliding Patio or Sliding French door after it has been permanently installed.

You will need to supply:

- Small putty knife
- Standard and #2 Phillips screwdriver

**01** Using small putty knife or standard screwdriver remove two roller adjustment hole caps from bottom rail of operating panel.

**02** Slide operating panel 1/2"-3/4" away from locking jamb.

**03** Adjust rollers (to raise/lower panel) by turning adjustment screws with standard screwdriver.

**04** If an even reveal is unobtainable along entire length of panel, ensure locking jamb is shimmed plumb and level.

**05** Check panel operation. If satisfactory, replace adjustment hole caps.

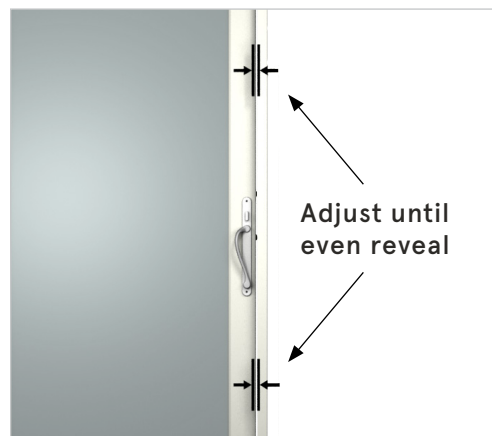

## Removing the Screen

To remove the screen panel, unlock and partially open the screen door. From the exterior, pry the screen panel guide up with a putty knife starting at one corner. Pull the guide off the track working your way toward the other end. Once the bottom of the screen panel is completely released from the sill track, pivot the bottom of the screen out and push the top of panel approximately 5 degrees toward the head jamb.

This will release the screen panel rollers from the head jamb screen track. Remove the panel from the door.

To reinstall the screen, hold the screen panel with the top rollers facing you. While tilting the bottom of the screen panel away from the door, lift the rollers into the screen track and pull the panel toward your body to engage the rollers in the track. Make sure the rollers are seated in the track by moving the screen panel back and forth. Once you are sure the rollers are fully seated, pivot the screen panel into position toward the sill and place the bottom screen panel guide into the sill track by lifting it with your fingers or by lifting with a stiff putty knife.

The screen can be adjusted from the interior by loosening or tightening the top roller screw nearest the locking jamb. Adjust the screen so that it is parallel to the locking jamb or casing. An even reveal should be achieved along the entire height of the jamb.

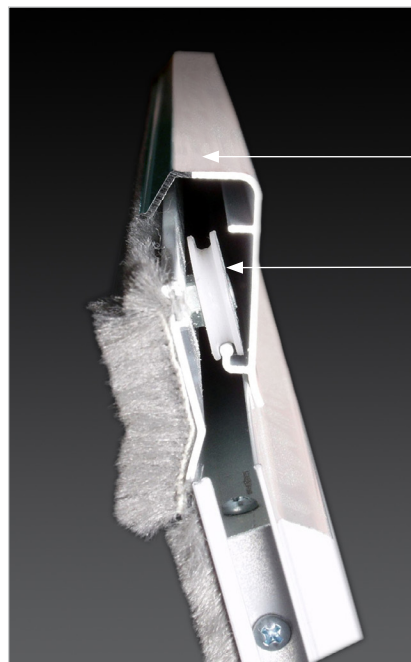

Screen Track

Screen Roller



# Inswing French Door

## Operation and Maintenance

The Inswing French door requires very little maintenance.

To maintain sill appearance, wash with a mild soap and water solution. If you need door panels removed, please contact your Infinity partner for either detailed instructions or for a service person to remove the panel for you. Visit [infinitywindows.com/doors/inswing-french](https://infinitywindows.com/doors/inswing-french) to find a video on proper cleaning and operation.

## Handle Operation for Multi-Point Lock

Always close and lock your passive panel first and the operating panel (with thumb turn) second. Infinity's multi-point hardware has locking bolts at the head and base of the door. Lifting the handle 45 degrees upward will set the head and foot bolts in place for a secure seal. A 90 degree turn of the key from the outside or the thumb turn on the inside will lock the deadbolt in the handle assembly. When the deadbolt is unlocked, downward pressure on the handles will release the bolts and latch and the door will open. Securely lock by engaging the deadbolt, head and foot bolts; using only one or the other does not offer full security.

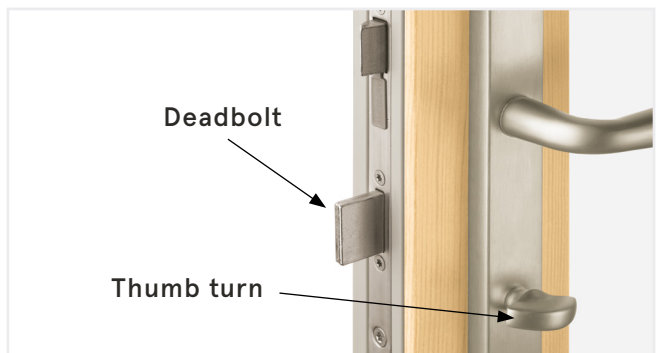
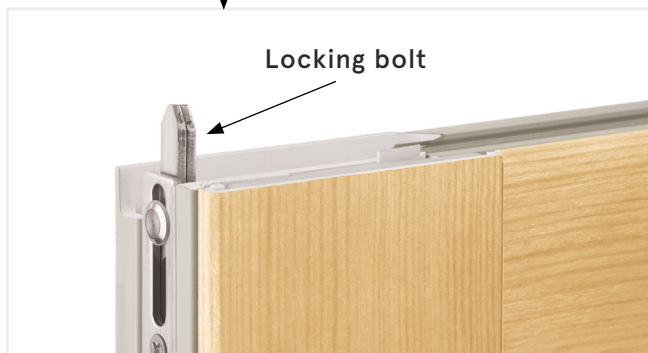
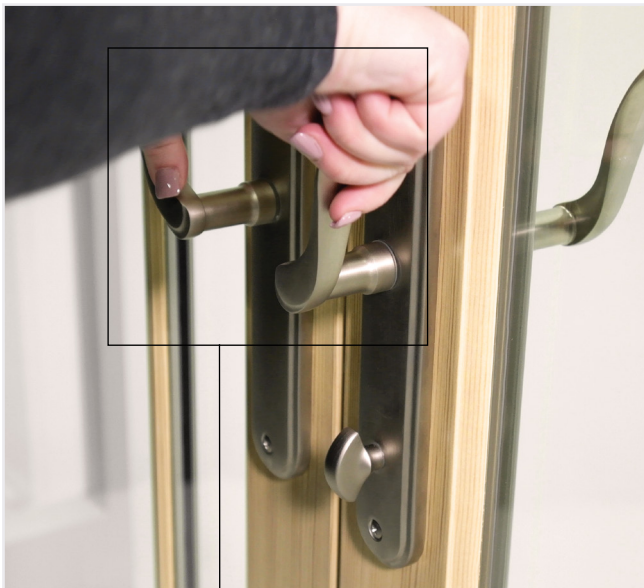

## Hinge Adjustment Procedure

The Infinity Inswing French Door's adjustable hinge system allows you to make minor adjustments after it has been permanently installed.

\*Adjustable hinges are not intended to compensate for an improperly installed unit.

Adjustments should only be made when panel misalignment is visible or causes poor operation of door/lock. Make any adjustments in small increments (one rotation per hinge), starting with the bottom hinge and working up to the top hinge. Repeat the process as necessary adjusting one rotation at a time. Check results, readjust or proceed as required.

The vertical adjustment screws are located on the bottom of the hinge barrels. The horizontal adjustment screws are located on the face of the hinges. Each screw has an adjustment range of approximately 7 turns.

- 01** Check panel clearance at sill and head jamb. The panel should have 3/16" (5 mm) clearance at head jamb and at bottom.
- 02** Align panel vertically as needed by adjusting the screws on the bottom of the hinge barrels. The vertical adjustment screw should be adjusted equal amounts starting with the bottom hinge. Check index mark on hinge to determine amount and direction of panel movement. See illustration.
- 03** Check panel alignment with locking jamb; panel should have 3/16" (5 mm) clearance along the jamb.
- 04** Rotate horizontal adjustment screw clockwise to decrease, counterclockwise to increase jamb/panel clearance at the appropriate hinge. If increasing clearance at top, bottom hinge may have to be adjusted to decrease clearance to avoid hinge binding. See illustration.

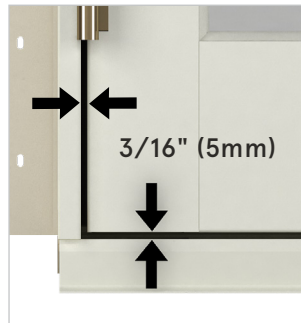
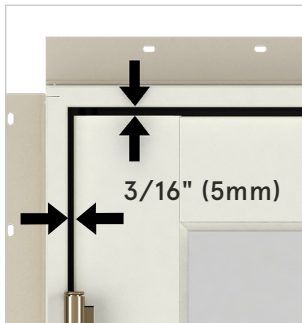

## Removing the Screen

If you live in a cold climate, it is recommended that during the winter months you remove the screen door to avoid snow and ice from collecting, causing the mesh to sag.

To remove the swinging screen door, first open the active screen panel and disconnect the auto closer. Remove the #6 x 1/2" screw attaching the closer to the head jamb bracket. Then remove the hinge pins from the active screen panel hinges, remove the panel from the hinges and store. On XX configurations, open the passive screen panel and remove the hinge pins in the same manner as the active.

Adjust the closing tension on your swinging screen door by loosening the two screws and attaching the door bracket to the screen panel. Slide the bracket and closer left or right as needed and tighten screws. Adjust the closing speed by tightening or loosening the adjusting screw located at the rear of the cylinder assembly.

\*Both panels operate in an XX configuration.

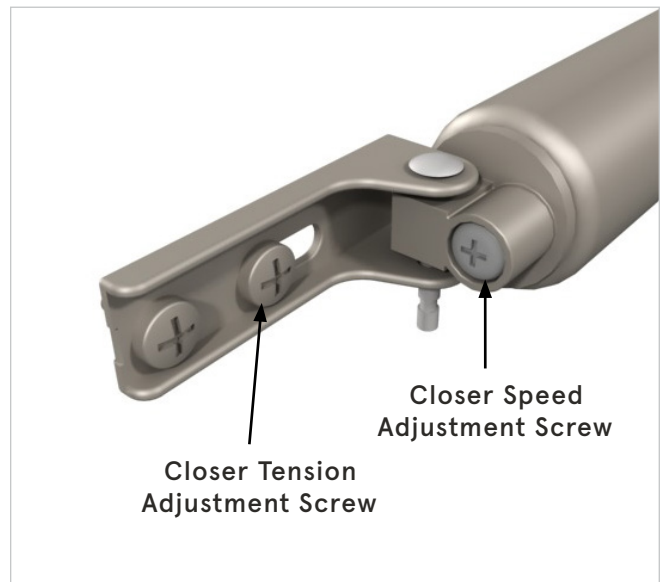

# Still have questions? We can help.

---

Thanks for purchasing Infinity windows and doors for your home.  
We're always here to help, and our local partners are, too.  
Give us a call or visit us online, anytime.

Call 1-800-372-1072 for homeowner support. In Canada, call 1-800-263-6161.  
Or visit us at [infinitywindows.com](https://infinitywindows.com).

©2020 Marvin Lumber and Cedar Co., LLC.  
All rights reserved. ©Registered trademark of Marvin Lumber and Cedar Co., LLC.  
ENERGY STAR® and the ENERGY STAR certification marks are registered U.S. marks.  
Product specifications subject to change without notice.

Part #19981932. March 2020.

**INFINITY**<sup>®</sup>  
from **MARVIN**  
REPLACEMENT WINDOWS  
*Built for life*<sup>®</sup>